

FOEHN & HIRSCH



OWNER'S MANUAL

FH-22LMG

Please read this manual carefully before operating your set.

Retain it for future reference.

Record the model number and serial number of the set.

PREPARATION

FRONT PANEL CONTROLS

- *This is a simplified representation of the front panel. The image shown may be somewhat different from your set.*

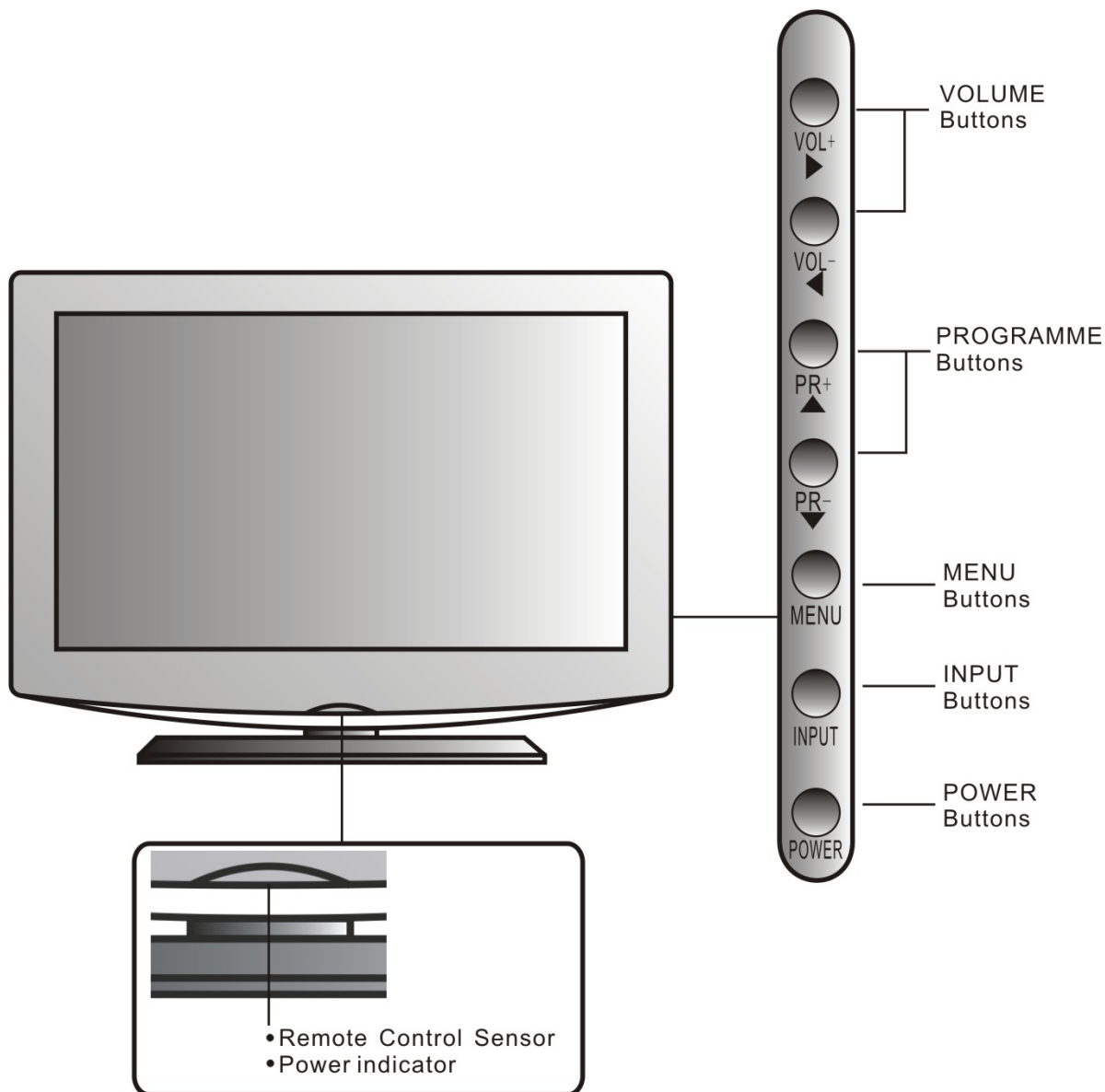

When the power indicator shows red, the TV is in stand by status.

When the power indicator shows green, the TV is on.

PREPARATION

BACK PANEL INFORMATION

- This is a simplified representation of the back panel. The image shown may be somewhat different from your set.

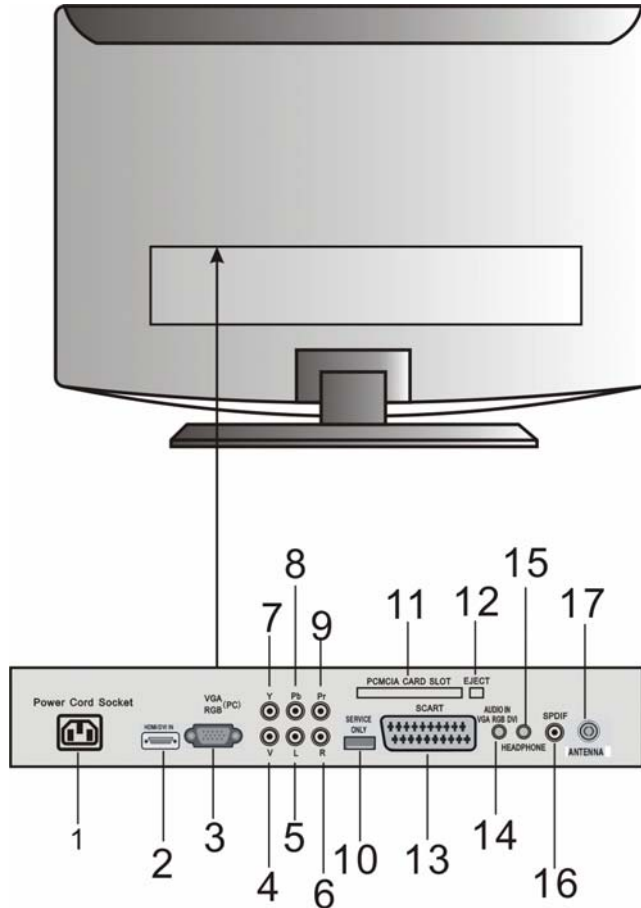

1. POWER CORD SOCKET
2. HDMI/DVI
3. VGA/RGB(PC) IN
4. Y: VIDEO INPUT
5. L: LEFT TRACK AUDIO INPUT
6. R: RIGHT TRACK AUDIO INPUT
7. Y IN
8. Pb IN
9. Pr IN
10. SERVICE ONLY
11. PCMCIA CARD SOLT
12. EJECT for PCMCIA CARD
13. SCART
14. AUDIO IN (VGA/RGB/DBI)
15. HEAD PHONE OUT
16. SPDIF
17. ANTENNA

PREPARATION

WALL MOUNT: HORIZONTAL INSTALLATION

- For proper ventilation, allow a clearance of 4 inches on each side and from the wall.

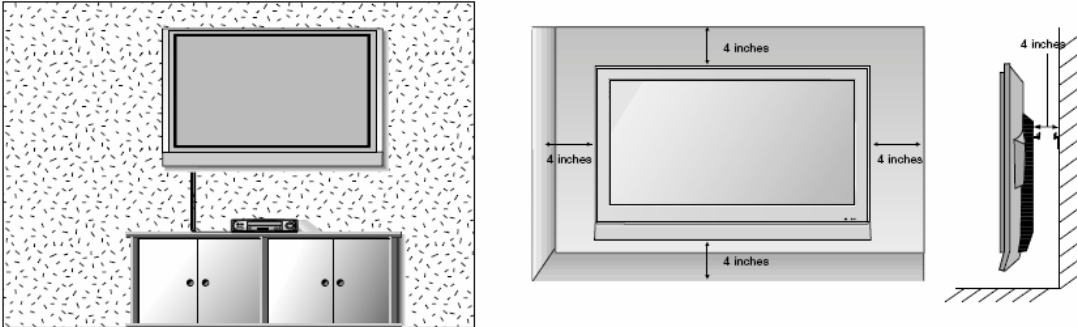

DESKTOP PEDESTAL INSTALLATION

- For proper ventilation, allow a clearance of 4 inches on each side and from the wall.

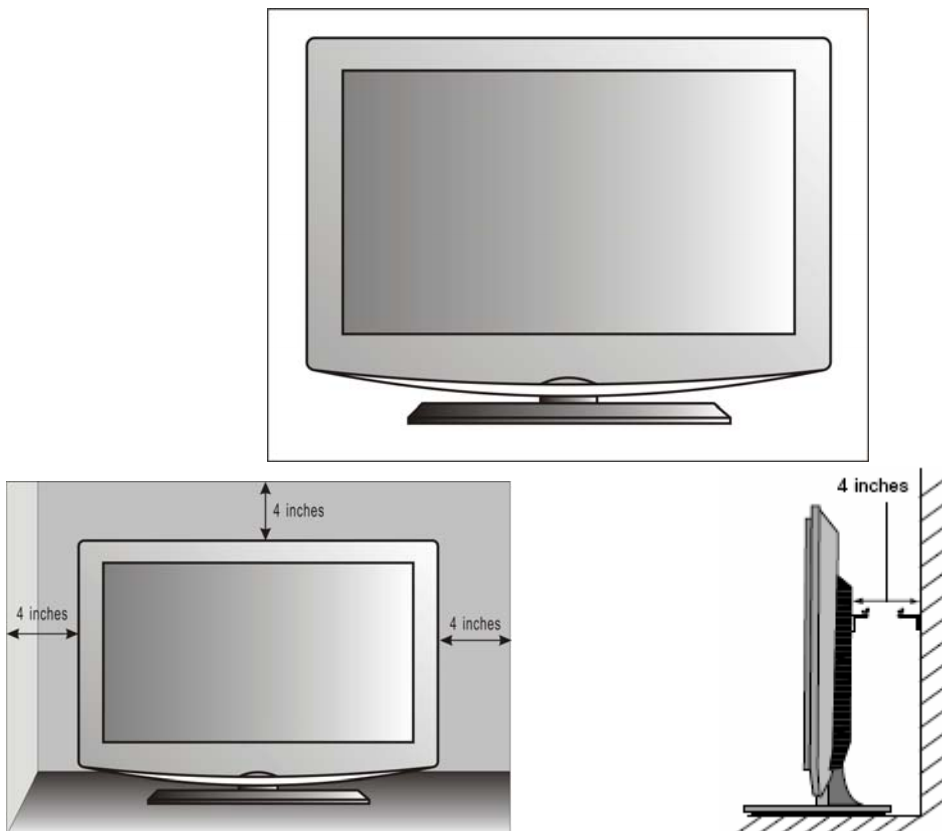

PREPARATION

- To prevent equipment damage, never plug in any power cords until you have finished connecting all equipment.

ANTENNA CONNECTION

- For optimum picture quality, adjust antenna direction.
- An antenna cable and converter are not supplied.

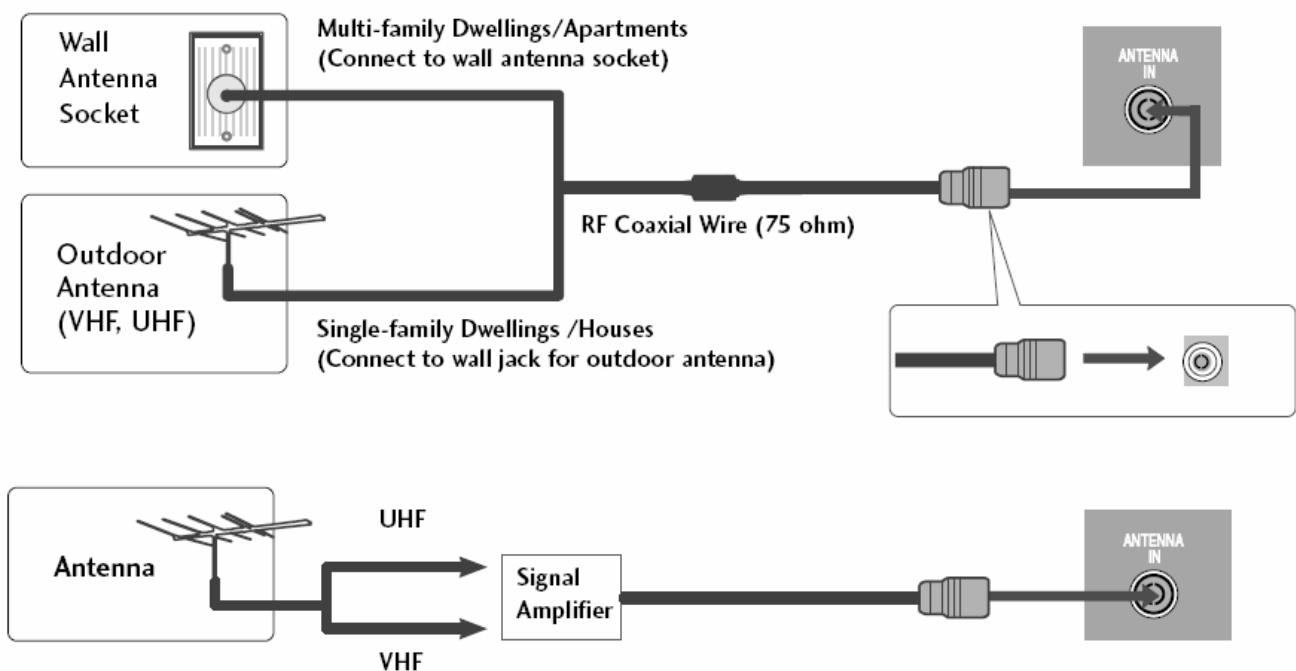

- In poor signal areas, to get better picture quality, install a signal amplifier to the antenna as shown above.
- If signal needs to be split for two TVs, use an antenna signal splitter for connection.

EXTERNAL EQUIPMENT SETUP

- To prevent equipment damage, never plug in any power cords until you have finished connecting all equipment.

HD RECEIVER SETUP

When connecting with a component cable

- 1) Connect the setup-box outputs to the Y Pb Pr (COMPONENT) IN sockets on the set.
- 2) Connect the audio cable from the setup-box to Y Pb Pr IN AUDIO sockets of the set.
- 3) Press the INPUT button to select Y Pb Pr.

Signal	Component	HDMI
480i/576i	Yes	No
480p/576p	Yes	Yes
720p/1080i	Yes	Yes
1080p	Yes	Yes

TV set →

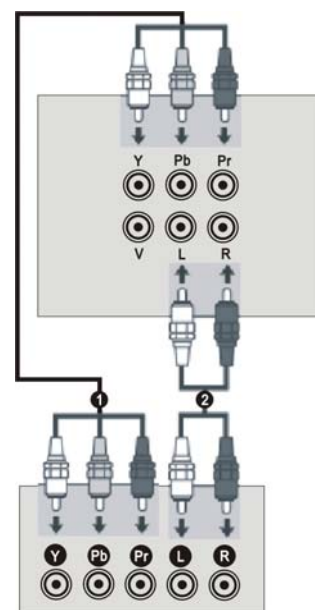

When connecting with a HDMI

Connect the HDMI output of the digital set-top box to the HDMI/DVI IN jack on the set.

TV set →

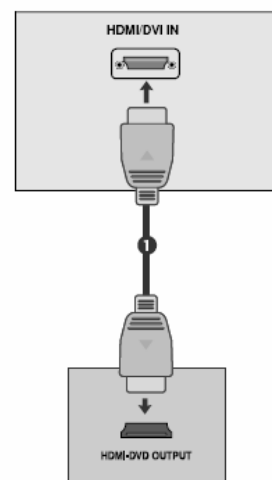

When connecting with a HDMI to DVI cable

- 1) Connect the digital set-top box to HDMI/DVI IN jack on the set.
- 2) Connect the audio output of the digital set-top box to the AUDIO IN (VGA/RGB/DVI) jack on the set.
- 3) Turn on the digital set-top box. (Refer to the owner's manual for the digital set-top box.)

EXTERNAL EQUIPMENT SETUP

- To prevent equipment damage, never plug in any power cords until you have finished connecting all equipment.

DVD SETUP

When connecting with a Y Pb Pr (component) cable

- 1) Connect the video output sockets (Y PB PR) of the DVD to the Y Pb Pr sockets of the set.
- 2) Connect the audio cable from the DVD to Y Pb Pr IN AUDIO sockets of the set.
- 3) Press the INPUT button to select YPbPr.
- 4) Press the PLAY button on the DVD. The DVD playback picture appears on the screen.

TV set →

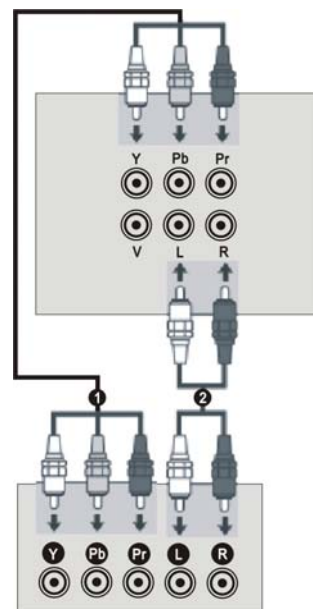

Y Pb Pr(Component) Input ports

To get better picture quality, connect a DVD player to the YPbPr(component) input ports as shown below.

Component ports on the set	Y	PB	PR
Video output ports on DVD player	Y	PB	PR
	Y	B-Y	R-Y
	Y	Cb	Cr
	Y	Pb	Pr

EXTERNAL EQUIPMENT SETUP

- *To prevent equipment damage, never plug in any power cords until you have finished connecting all equipment.*

DVD SETUP

When connecting with a Euro SCART

Connect the Euro scart socket of the DVD to the Euro scart socket of the set..

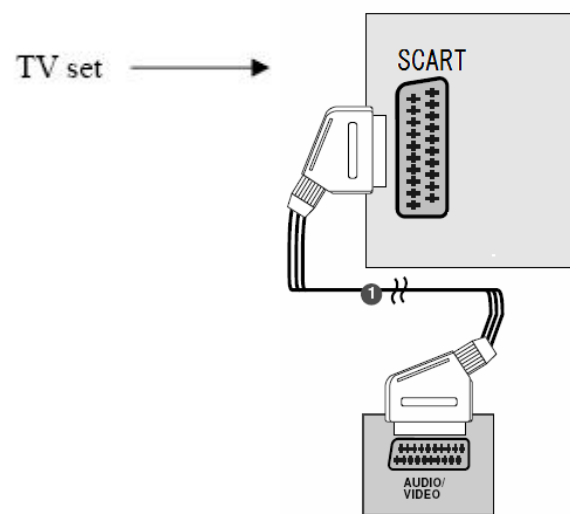

NOTE

- ① Please use shielded scart cable.

When connecting HDMI cable

Connect the HDMI output of the DVD to the HDMI/DVI IN jack on the set.

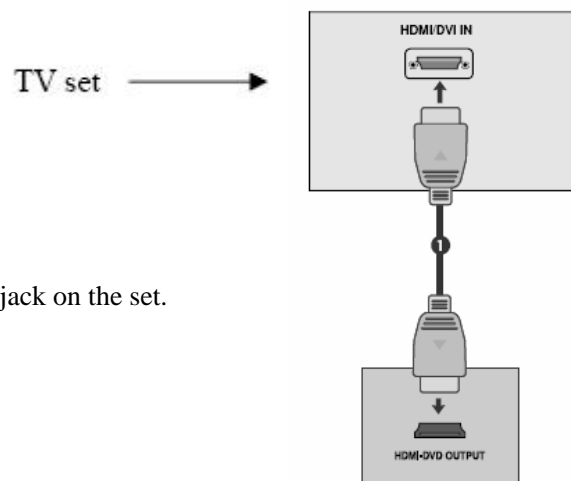

EXTERNAL EQUIPMENT SETUP

- *To prevent equipment damage, never plug in any power cords until you have finished connecting all equipment.*

DVD SETUP

TV set →

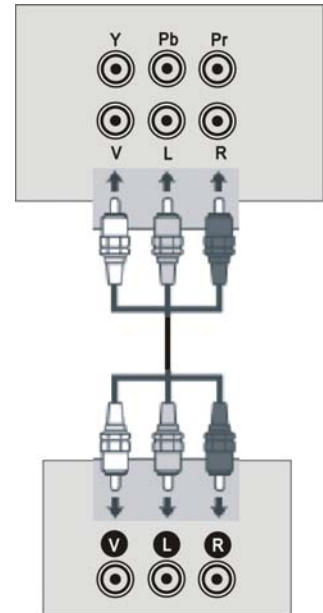

When connecting with CVBS

- 1) Connect the DVD video output to the video in on the set
- 2) Connect the DVD audio(L/R) out to the audio in on the set.
- 3) Press the PLAY button on the DVD. The DVD playback picture appears on the screen.

EXTERNAL EQUIPMENT SETUP

- To prevent equipment damage, never plug in any power cords until you have finished connecting all equipment.

VCR SETUP

To avoid picture noise (interference), leave an adequate distance between the VCR and set.

Typically a still picture is shown on the VCR. If a user uses 4:3 picture format for a long time, an afterimage may remain on the sides of the screen.

When connecting with an antenna

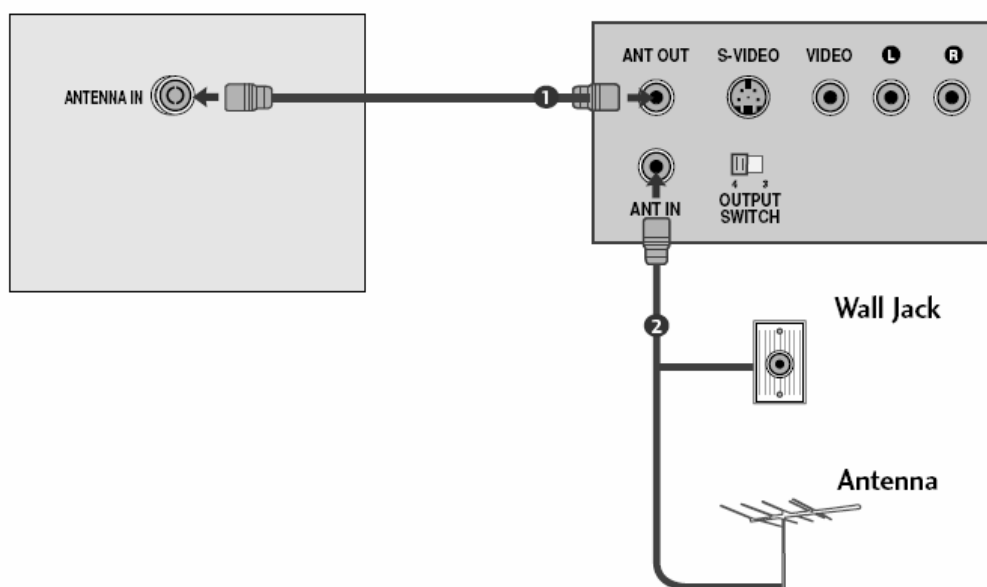

- 1) Connect the RF out socket of the VCR to the antenna socket of the set.
- 2) Connect the aerial cable to the RF aerial in socket of the VCR.
- 3) Store the VCR channel on a desired programme number using the 'Manual programme tuning' section.
- 4) Select the programme number where the VCR channel is stored.
- 5) Press the PLAY button on the VCR.

When connecting with a Euro Scart

Connect the Euro scart socket of the VCR to the Euro scart socket of the set.

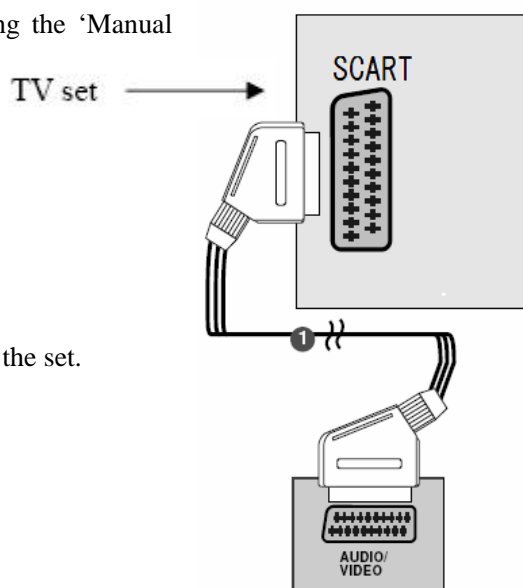

NOTE

- 1 Please use shielded scart cable.

INSERTION OF CI MODULE

To view the scrambled (paid) services in digital TV mode.

This feature is not available in all countries.

Insert the CI Module to PCMCIA (Personal Computer Memory Card International Association) CARD SLOT of set as shown.

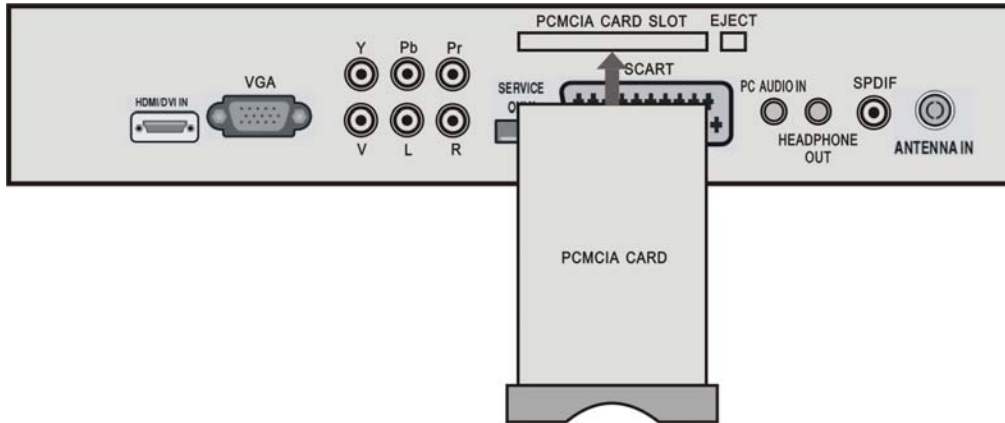

EXTERNAL EQUIPMENT SETUP

PC SETUP

- *To prevent equipment damage, never plug in any power cords until you have finished connecting all equipment.*

This product provides Plug and Play capability, meaning that the PC adjusts automatically to the set's settings, when connecting with a D-sub 15 pin cable

- ① Connect the signal cable from the monitor output socket of the PERSONAL COMPUTER to the PC input socket of the set.
- ② Connect the audio cable from the PC to the AUDIO IN (VGA/RGB/DVI) sockets of the set.
- ③ Press the INPUT button to select VGA.
- ④ Switch on the PC, and the PC screen appears on the set. The set can be operated as a PC monitor.

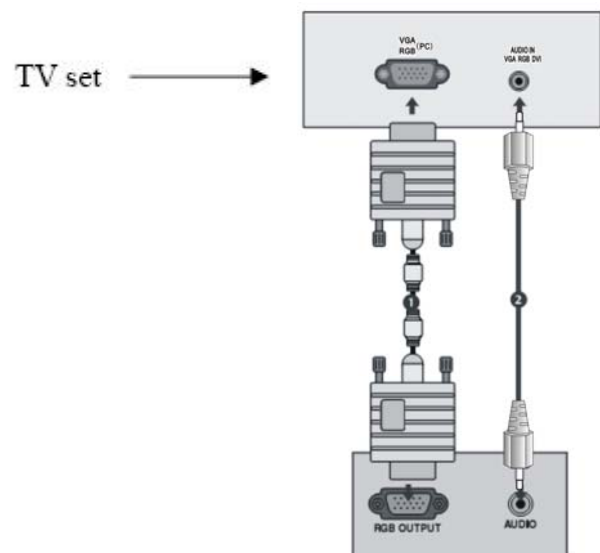

NOTE

User must use shielded signal interface cables (D sub 15 pin cable, DVI cable) with ferrite cores to maintain standard compliance for the product.

EXTERNAL EQUIPMENT SETUP

PC SETUP

- *To prevent equipment damage, never plug in any power cords until you have finished connecting all equipment.*

When connecting with a HDMI to DVI cable

Connect the DVI output of the PC to the HDMI/DVI IN jack on the set.

Connect the audio cable from the PC to the AUDIO IN (VGA/RGB/DVI) sockets of the set.

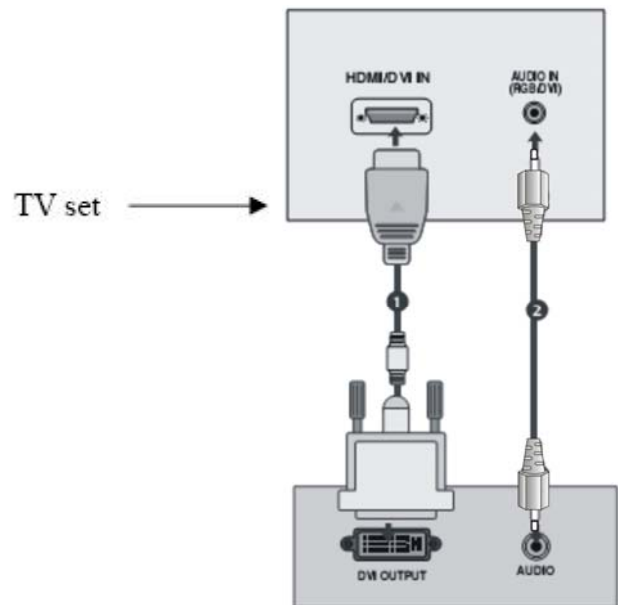

NOTE

- ① If the set is cold, there may be a small "flicker" when the set is switched on. This is normal, there is nothing wrong with the set.
- ② If possible, use the 1680x1050 @ 60 Hz video mode to obtain the best image quality for your LCD monitor. If used with other resolutions, some scaled or processed pictures may appear on the screen. The set has been preadjusted to the mode 1680x1050 @ 60 Hz.
- ③ Some dot defects may appear on the screen, like Red, Green or Blue spots. However, this will have no impact or effect on the monitor performance.
- ④ Do not press the LCD screen with your finger for a long time as this may produce some temporary distortion effects on the screen.
- ⑥ Avoid keeping a fixed image on the set's screen for prolonged periods of time. The fixed image may become permanently imprinted on the screen; use a screen saver when possible.

EXTERNAL EQUIPMENT SETUP

PC SETUP

- *To prevent equipment damage, never plug in any power cords until you have finished connecting all equipment.*

When connecting with a HDMI to HDMI cable

Connect the HDMI output of the PC to the HDMI/DVI IN jack on the set

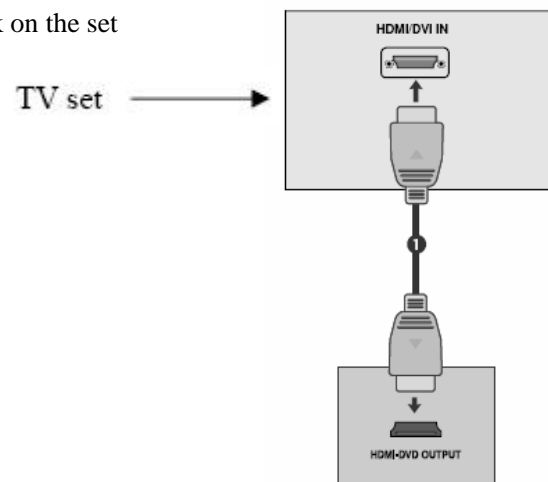

NOTE

- ① If the set is cold, there may be a small “flicker” when the set is switched on. This is normal, there is nothing wrong with the set.
- ② If possible, use the 1680x1050 @ 60 Hz video mode to obtain the best image quality for your LCD monitor. If used with other resolutions, some scaled or processed pictures may appear on the screen. The set has been preadjusted to the mode 1680x1050 @ 60 Hz.
- ③ Some dot defects may appear on the screen, like Red, Green or Blue spots. However, this will have no impact or effect on the monitor performance.
- ④ Do not press the LCD screen with your finger for a long time as this may produce some temporary distortion effects on the screen.
- ⑤ To enjoy best image quality for your LCD monitor, please change Input label to ‘PC’
- ⑥ Avoid keeping a fixed image on the set’s screen for prolonged periods of time. The fixed image may become permanently imprinted on the screen; use a screen saver when possible.

EXTERNAL EQUIPMENT SETUP

Model: FH-22LMG

RGB/HDMI [PC] Preset mode

Resolution	Horizontal Frequency (kHz)	Vertical Frequency (Hz)
720x400	31.468	70
640x480	31.469	60
	37.500	75
800x600	37.879	60
	46.875	75
1024x768	48.363	60
	60.123	75
1152x864	67.500	75
1280x1024	63.981	60
	79.976	75
1680x1050	64.674	60
	65.290	60

HDMI/DVI-DTV supported mode

Resolution	Horizontal Frequency (kHz)	Vertical Frequency (Hz)
720x480/60p	31.47	60
	31.5	60
720x576/50p	31.25	50
1280x720/50p	37.5	50
1280x720/60p	44.96	60
	45	60
1920x1080/60i	33.72	60
	33.75	60
1920x1080/50i	28.125	50
1920x1080/50p	56.25	50
1920x1080/60p	67.5	60

EXTERNAL EQUIPMENT SETUP

Screen Setup for PC mode

Adjustment for screen Position, Size, Phase

If the picture is not clear after auto adjustment and especially if characters are still shaky, adjust the picture phase manually.

This function works in the following mode: VGA

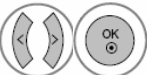
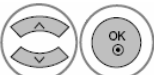
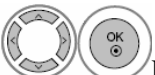
-  Press menu button to display the menu
-  Press left/right button to select the Picture menu and press OK
-  Press the down button to select the PC Setup and press OK
-  Press UP/down button to select H.Position, V. Position, Clock, Phase
Press left/right button for adjustment



- Press the EXIT button to close the menu window.
- Press the MENU button to move to the previous menu screen.







EXTERNAL EQUIPMENT SETUP

Auto Configure (VGA mode only)

Automatically adjusts picture position and minimizes image instability. After adjustment, if the image is still not correct, your set is functioning properly but needs further adjustment.

Auto configure

This function is for automatic adjustment of the screen position, clock, and phase. The displayed image will be unstable for a few seconds while the auto configuration is in progress.

- 1、 Press menu button to display the menu
- 2、  Press left/right button to select the Picture menu and press OK
- 3、  Press the down button to select the PC Setup and press OK
- 4、 Press UP/down button to select the Auto Adjust
- 6、 Press the light button to auto Adjustment



- Press the EXIT button to close the menu window.
- Press the MENU button to move to the previous menu screen.

WATCHING TV /PROGRAMME CONTROL

REMOTE CONTROL KEY FUNCTIONS

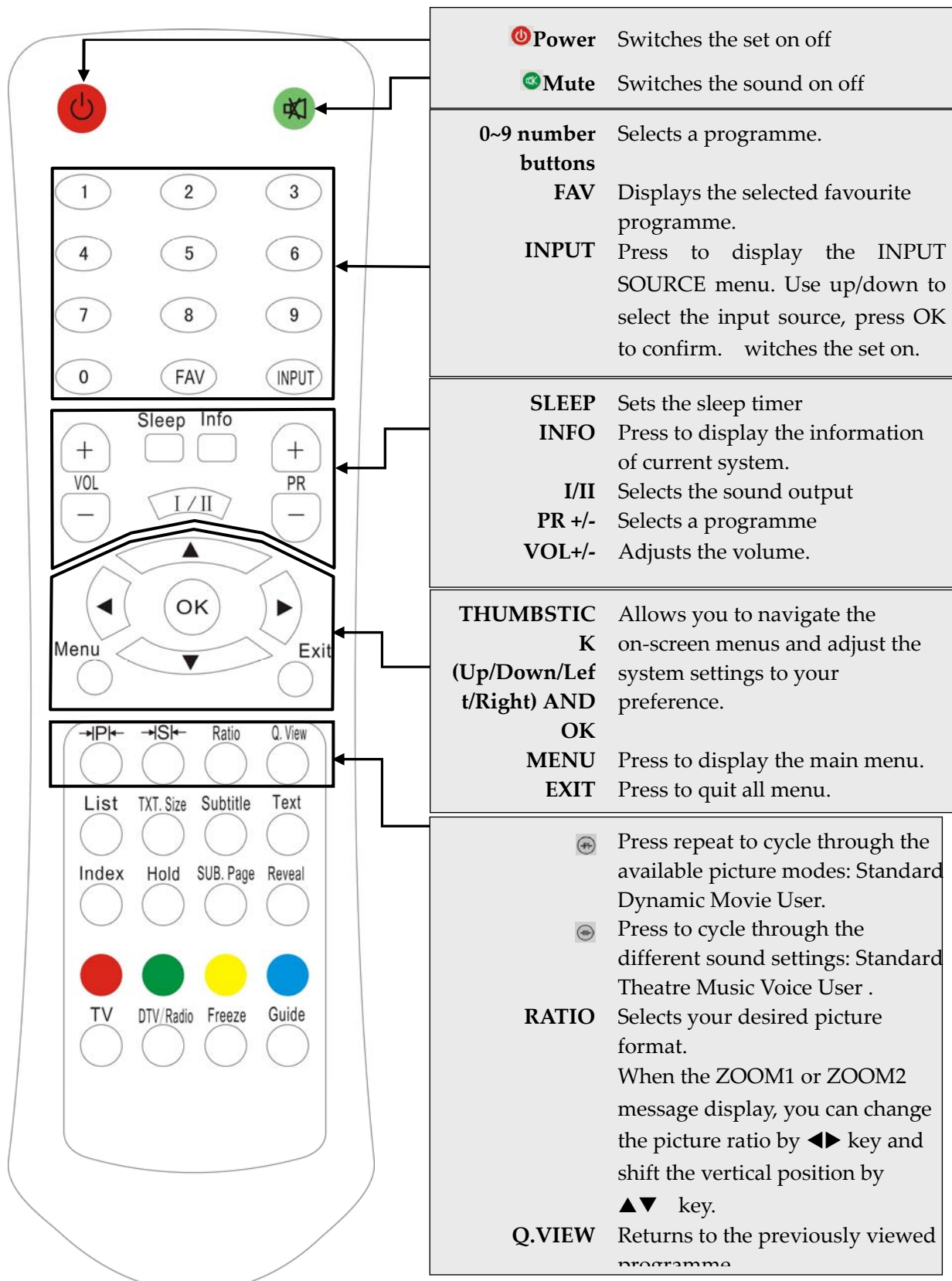

WATCHING TV /PROGRAMME CONTROL

REMOTE CONTROL KEY FUNCTIONS

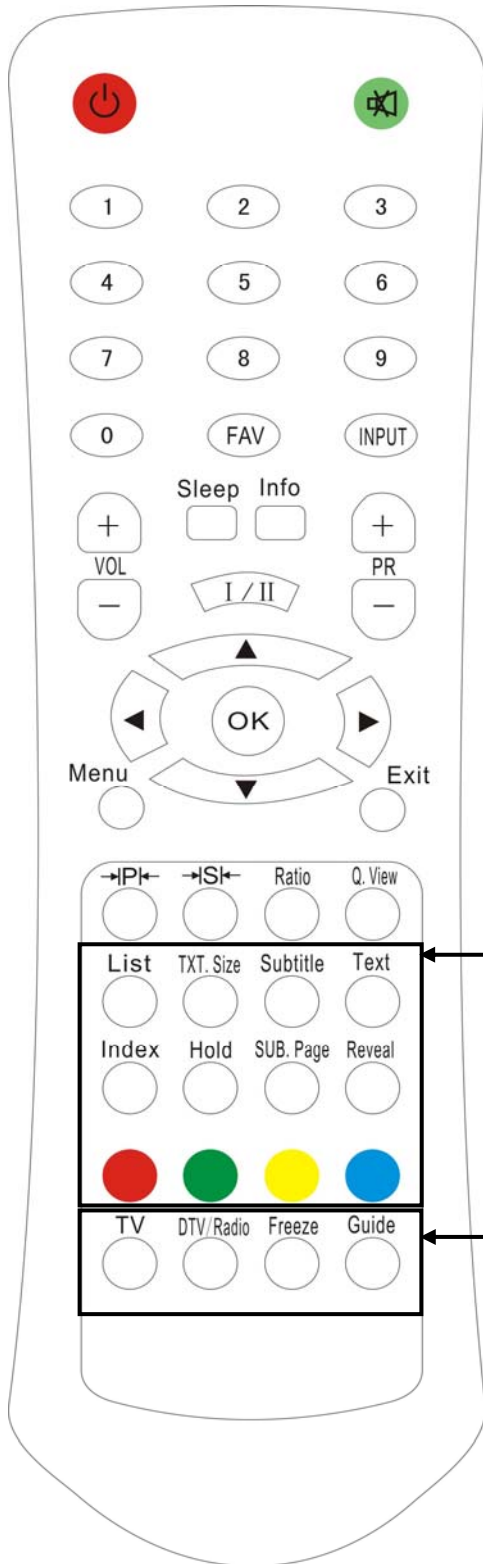

LIST • Displays the programme table. •• **TXT SIZE** • Toggles the display between half top page ,half bottom page and normal. •• **SUBTITLE** • Recalls your preferred subtitle in digital mode. •• **TEXT ON/OFF** Teletext. •• **INDEX** • Teletext index page. •• **HOLD** • Stop refurbish current page. •• **SUB. PAGE** • Prompt the user to enter a subcode for the page •• **REVALE** • Display hidden characters. •• **COLOURED BUTTON** • These buttons are used for teletext (only TELETEXT models) or Programme edit. ••

TV • Directly switch to ATV source from any other source •• **DTV/RADIO** • Directly switch to DTV source from any other source, and switch between DTV and radio. •• **FREEZE** • Freeze or un-freeze picture •• **GUIDE** • Open or close EPG menu ••

Installing Batteries

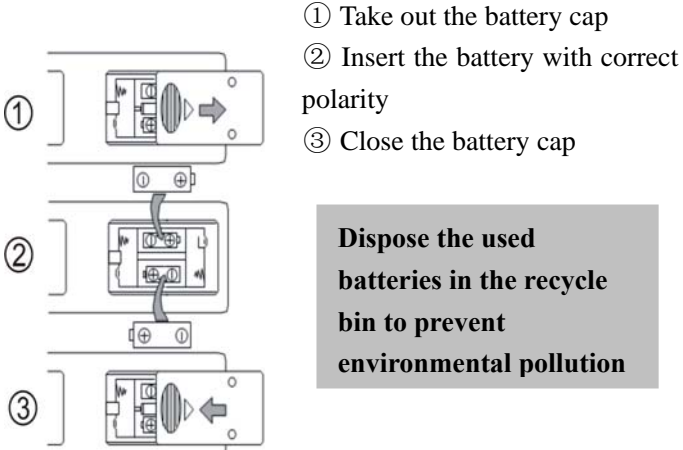

Dispose the used batteries in the recycle bin to prevent environmental pollution

WATCHING TV /PROGRAMME CONTROL

TURNING ON THE TV

If your TV is turned on, you will be able to use its features.

- ① First, connect power cord correctly.
- ② Turn on power by pressing the power button on the product.
- ③ Press the TV or DTV button on the remote control.
- ④ Set the channel by using the PR+ / - buttons or number buttons on the remote control.

Initializing setup

If the OSD (On Screen Display) is displayed on the screen as figure after turning on the set, you can adjust the Language, Country, Time Zone, Auto programme tuning.

PROGRAMME SELECTION

Press the PR + or - or NUMBER buttons to select a programme number.

VOLUME ADJUSTMENT

Press the VOL + or - button to adjust the volume.

If you want to switch the sound off, press the MUTE button.

You can cancel this function by pressing the MUTE, VOL + or -, or I/II button.

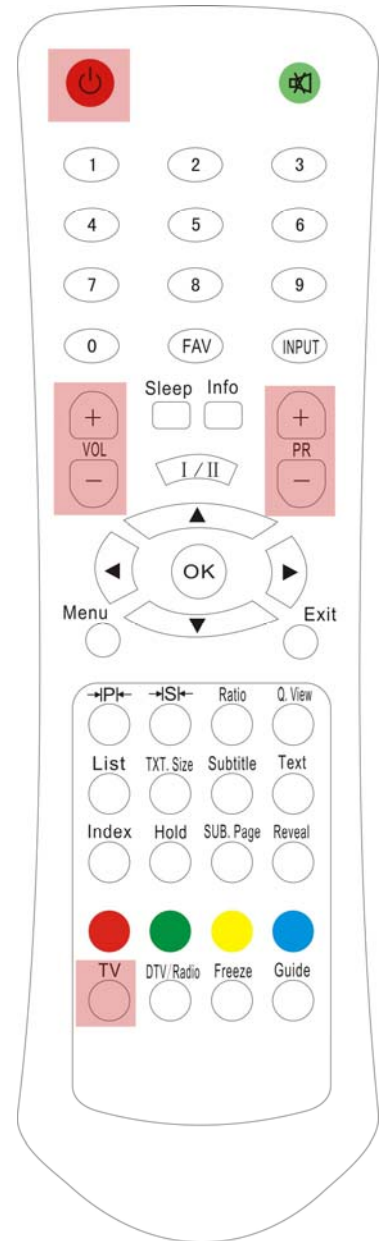









WATCHING TV /PROGRAMME CONTROL

AUTO PROGRAMME TUNING

Use this to automatically find and store all available programmes

When you start auto programming, all previously stored service or channel information will be deleted.

- 1、 Press menu button to display the menu
- 2、  Press left/right button to select the TV SETTING menu and press OK to continue.
- 3、  Press UP/down button to Select the Auto-Tuning, and press OK to continue.
- 4、  Press left/right button to select country and press OK to continue.
- 5、 Press OK again to start auto tuning

Note:

Press EXIT button to stop auto tuning.

Press MENU button to skip Analog tuning.









- Press the EXIT button to close the menu window.
- Press the MENU button to move to the previous menu screen.

WATCHING TV /PROGRAMME CONTROL

MANUAL PROGRAMME TUNING (IN DIGITAL MODE)

Manual Tuning lets you manually add a programme to your programme list.

- 1、 Press menu button to display the menu.
- 2、  Press left/right button to select the TV SETTING menu and press OK.
- 3、  Press up/down button to select the DTV Manual Tuning and press OK.
- 4、  Press left/right button to select the desired channel number then press OK.

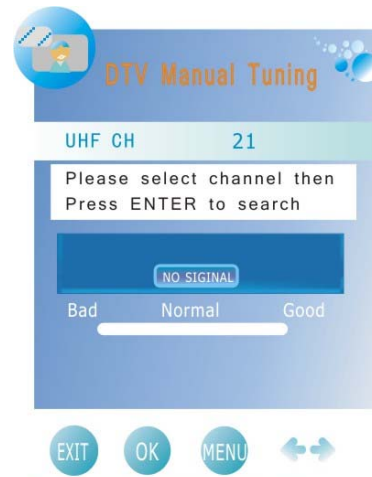





- Press the EXIT button to close the menu window.
- Press the MENU button to move to the previous menu screen.

WATCHING TV /PROGRAMME CONTROL

MANUAL PROGRAMME TUNING (IN ANALOGUE MODE)

Manual Tuning lets you manually tune and arrange the stations in whatever order you desire

- 1、 Press menu button to display the menu
- 2、 Press up/down button to select the ATV Manual tuning and press OK
- 3、 Press up/down button to select storage number and system. Press left/right button to change storage number and system.
- 4、 Hight light the “Search”, press right button to start search.

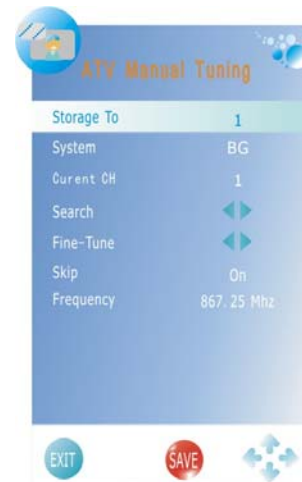







- Press the EXIT button to close the menu window.
- Press the MENU button to move to the previous menu screen.

WATCHING TV /PROGRAMME CONTROL

Fine Tuning

Normally fine tuning is only necessary if reception is poor.

- 1、 Press menu button to display the menu
- 2、  Press up/down button to select the ATV-Manual turning and press OK
- 3、 Press up/down to select storage number and system
- 4、  Press up/down button to select the Fine. Press left/right to fine tune the channel.



- Press the EXIT button to close the menu window.
- Press the MENU button to move to the previous menu screen.

WATCHING TV /PROGRAMME CONTROL





PROGRAMME EDIT

When a programme number is skipped, it means that you will be unable to select it using PR +/- button during TV viewing.

If you wish to select the skipped programme, directly enter the programme number with the NUMBER buttons or select it in the Programme edit menu

This function enables you to skip the stored programmes.

In some countries, it is possible to move a programme number by using the YELLOW button only.

- 1、 Press menu button to display the menu
- 2、  Press left/right button to select the TV-setting menu and press OK
- 3、  Press the down button to select the Programme-Edit and press OK button



Press the EXIT button to close the menu window.



•Press the MENU button to move to the previous menu screen

WATCHING TV /PROGRAMME CONTROL



IN DTV/RADIO MODE

The Programme Edit menu will show after you press OK button



Skipping a programme number

- 1、 Press UP/down button to select Programme
 - 2、 Press Blue button to skipping Programme
-

Deleting a programme number

- 1、 Press up/down button to select Programme
 - 2、 Press Red button to deleting Programme
-

Selecting favourite programme

- 1、 Press up/down button to select programme
- 2、 Press FAV button to select desired programme



Press the EXIT button to close the menu window.



•Press the MENU button to move to the previous menu screen.

WATCHING TV /PROGRAMME CONTROL



IN TV MODE

This function enables you to delete or skip the stored programmes. You can also move some channels to other programme numbers.



Skipping a programme

- 1、 Press UP/down button to select Programme
- 2、 Press Blue button to skipping Programme



Skipping a programme

- 1、 Press up/down button to select Programme
- 2、 Press Red button to deleting Programme



Moving a programme

- 1、 Press UP/down button to select Programme
- 2、 Press Yellow button to moving Programme

Rename a programme

- 1、 Press up/down button to select Programme
- 2、 Press Green button to rename Programme
- 3、 Use up/down button to select desired char and use left/right to edit each char.

Selecting favourite programme

- 1、 Press UP/down button to select Programme
- 2、 Press Fav button to select desired Programme

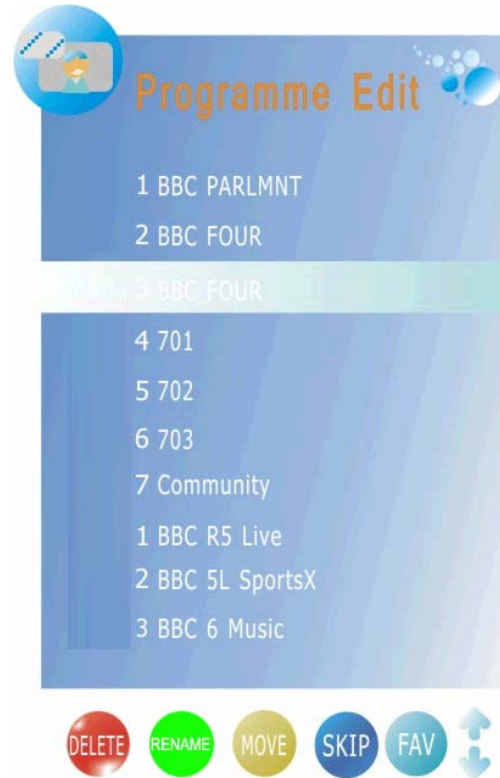

Press the EXIT button to close the menu window.

•Press the MENU button to move to the previous menu screen.

WATCHING TV /PROGRAMME CONTROL



CI [COMMON INTERFACE] INFORMATION

This function enables you to watch some encrypted services (paid services). If you remove the CI Module, you cannot watch paid services.

When the module is inserted into the CI slot, you can access the module menu.

To purchase a module and smart card, contact your dealer. Do not repeatedly insert or remove a CAM module from the set. This may cause a malfunction. When the set is turned on after inserting a CI Module, you may not have any sound output. This may be incompatible with the CI module and smart card.

CI (Common Interface) functions may not be possible depending upon the country broadcasting circumstances.

- 1、 Press menu button to display the menu
- 2、 Press left/right button to select the TV-setting menu and press OK
- 3、 Press the down button to select the CI Information and press OK button



Note:

The OSD after you press OK button may varied according to the Digital pay service provider.

WATCHING TV /PROGRAMME CONTROL

SELECTING THE PROGRAMME TABLE

You can check which programmes are stored in the memory by displaying the programme table.

Displaying programme LIST



Press LIST button to Display the PROGRAMME LIST.

Selecting a programme in the programme list



Press UP/down button to select Programme.



Switch to the chosen programme number.

Paging through a programme list



Turns the pages.

Displaying the favourite programme table



Press FAV button to Display the Favourite Programme table.

EPG (ELECTRONIC PROGRAMME GUIDE)

(IN DIGITAL MODE)

This system has an Electronic Programme Guide (EPG) to help navigate through all the possible viewing options. The EPG supplies information such as programme listings, start and end times for all available services. In addition, detailed information about the programme is often available in the EPG (the availability and amount of these programme details will vary, depending on the particular broadcaster).

This function can be used only when the EPG information is broadcasted by broadcasting companies.

The EPG displays the programme description for the next eight days.

Switch on/off EPG



Switch on or off EPG.



It is only available by DTV source.

Press the ▲▼◀▶ button to move the cursor (high light area), press "OK" button to switch to current channel, and the other operation as the navigate information below the menu

Green button (Schedule) >>Review the program information saved in list

Yellow button (Date) >>To browse the program information in the seven days

Blue button (Reminder) >>To add current program to the list, and it would be switch on time

PICTURE CONTROL

PICTURE SIZE (ASPECT RATIO) CONTROL

You can watch the screen in various picture formats; Auto,16:9, 4:3, 14:9 and Zoom1/2.

If a fixed image is displayed on the screen for a long time, that fixed image may become imprinted on the screen and remain visible.

You can adjust the enlarge proportion using **Size** button.

·16:9

The following selection will allow you to adjust the picture horizontally, in linear proportion, to fill the entire screen (useful for viewing 4:3 formatted DVDs).



·4:3

The following selection will allow you to view a picture with an original 4:3 aspect ratio, grey bars will appear on both the left and right of the screen.



·Zoom1

The following selection will allow you to view the picture without any alteration, while filling the entire screen. However, the top and bottom of the picture will be cropped.

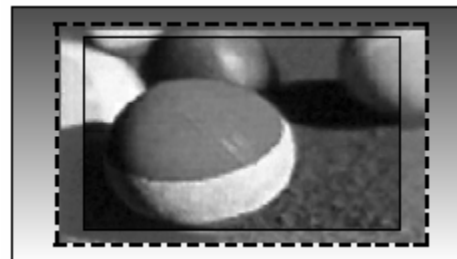

·Zoom2

Choose Zoom 2 when you wish the picture to be altered, both horizontally extended and vertically cropped. The picture adopting a compromise between alteration and screen coverage.



·Auto

When your TV receives a wide screen signal, it will automatically change to the picture format broadcast

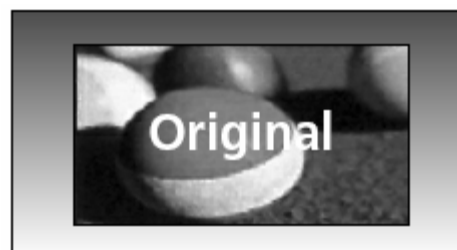

PICTURE CONTROL





PRESET PICTURE SETTING

Picture Mode-Preset

Method one

Press , you can select Picture Mode faster.

Method two

1.  Press menu button to display the menu
2.  Press OK to display the picture menu
3.  Press OK to select Picture mode
4.  Press left/right button to select the Picture mode Standard/Movie/User/Dynamic







- Press the EXIT button to close the menu window.
- Press the MENU button to move to the previous menu screen.

PICTURE CONTROL

Auto Colour Tone Control (Warm/Medium/Cool)

Choose one of three automatic colour adjustments. Set to warm to enhance warm colours such as red, or set to cool to see less intense colours with more blue.

- 1  Press menu button to display the menu
- 2  Press OK to display the picture menu
- 3  Press down button to select the Colour-temp
- 4  Press left/right button to select Colour Temp mode Warm/Medium/Cool/User









- Press the EXIT button to close the menu window.
- Press the MENU button to move to the previous menu screen.

PICTURE CONTROL

MANUAL PICTURE ADJUSTMENT

Picture Mode-User option

- 1  Press menu button to display the menu
- 2  Press OK to display the picture menu
- 3  Press OK to select the Picture mode
- 4  Press left/right button to select the Picture mode -User
- 5  Press the down button to select the Contrast,Brightness,Colour,Sharpness
Select Backlight, Contrast, Brightness, Sharpness or Colour .
- 6  Press left/right button to Make appropriate adjustments



NOTE





You cannot adjust colour, sharpness and tint in the RGB, HDMI[PC] mode.

- Press the EXIT button to close the menu window.
- Press the MENU button to move to the previous menu screen.

SOUND & LANGUAGE CONTROL

AUTO VOLUME LEVELER

AVL automatically remains on the same volume level if you change programmes.

- 1  Press menu button to display the menu
- 2   Press left/right button to select the SOUND menu and press OK,
- 3  Press the down button to select the Auto-Volume
- 4  Press left/right button to select ON or OFF



- Press the EXIT button to close the menu window.
- Press the MENU button to move to the previous menu screen.

SOUND & LANGUAGE CONTROL

PRESET SOUND SETTINGS – SOUND MODE

You can select your preferred sound setting; Standard, Music, Theater, Voice or User.

Sound Mode lets you enjoy the best sound without any Special adjustment as the TV set's the appropriate sound options based on the programme content.

Standard, Music, Theater, Voice are preset for optimum sound quality at the factory.

Method one



Press , you can select the Sound Mode faster.

Method two



1 Press menu button to display the menu

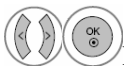

2 Press left/right button to select the SOUND and press OK



3 Press the down button to select the Sound Mode









4 Press left/right button to select the Sound Mode Standard , Music, Theater, Voice or User



- Press the EXIT button to close the menu window.
- Press the MENU button to move to the previous menu screen.

SOUND & LANGUAGE CONTROL

SOUND SETTING ADJUSTMENT – USER MODE

- 1  Press menu button to display the menu
- 2   Press left/right button to select the SOUND and press OK
- 3  Press UP/down button to select the Sound Mode
- 4  Press left/right button to select Sound-mode User
- 5  Press UP/down button to select Treble BASS
- 6  Press left/right button to Make appropriate adjustments.







- Press the EXIT button to close the menu window.
- Press the MENU button to move to the previous menu screen.

SOUND & LANGUAGE CONTROL

BALANCE

You can adjust the sound balance of the speakers to preferred levels.

- 1  Press menu button to display the menu
- 2   Press left/right button to select the SOUND and press OK
- 3  Press UP/down button to select the Balance
- 4  Press left/right button to Make appropriate adjustments.



- Press the EXIT button to close the menu window.
- Press the MENU button to move to the previous menu screen.

SOUND & LANGUAGE CONTROL

Stereo/Dual Reception (In Analogue Mode Only)

When a programme is selected, the sound information for the station appears after the programme number and station name disappear.



Press button

Select the sound output. (In Analogue Mode Only)

Mode: EREO I/ II

Select the LANGUAGE SELECTION (IN DIGITAL MODE)

NICAM Reception (In Analogue Mode Only)

If the set is equipped with the receiver for NICAM reception, high quality NICAM (Near Instantaneous Companded Audio Multiplex) digital sound can be received.

Sound output can be selected according to the type of received broadcast as follows by pressing the I/II button repeatedly.

1 When NICAM mono is received, you can select NICAM MONO or FM MONO.

2 When NICAM stereo is received, you can select NICAM STEREO or FM MONO.

If the stereo signal is weak, switch to FM mono.

Speaker Sound Output Selection

In AV, Component, RGB and HDMI mode, you can select output sound for the left and right loudspeakers.

Repeatedly press the I/II button to select the sound output.



L+R: Audio signal from audio L input is sent to the left loud speaker and audio signal from audio R input is sent to the right loud speaker.

L+L: Audio signal from audio L input is sent to left and right loud speakers.

R+R: Audio signal from audio R input is sent to left and right loud speakers

SOUND & LANGUAGE CONTROL

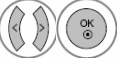
ON-SCREEN MENU LANGUAGE SELECTION

- 1  Press menu button to display the menu
- 2  Press left/right button to select the SETUP and press OK
- 3  Press the down button to select the Language
- 4  Press left/right button to Make appropriate adjustments











- Press the EXIT button to close the menu window.
- Press the MENU button to move to the previous menu screen.

TIME SETTING

CLOCK SETUP

The clock is set automatically when receiving a digital signal. (You can set the clock manually only if the set has no DTV signal.)

You must set the time correctly before using on/off timer function

- 1  Press menu button to display the menu
- 2   Press left/right button to select the Time, and press OK
- 3   Select the Clock and press OK
- 4   Make appropriate adjustments Date Month Year Hour Minute
- 5   After finish to select the close and press OK to exit the menu



- Press the EXIT button to close the menu window.
- Press the MENU button to move to the previous menu screen.

TIME SETTING

AUTO ON/OFF TIMER SETTING





The Off time function automatically switches the set to standby at a preset time.

Two hours after the set is switched on by the on time function it will automatically switch back to standby mode unless a button has been pressed.

The Off time function overrides the On timer function if both are set to the same time.

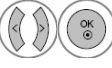
The set must be in standby mode for the On timer to work.

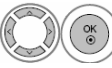
AUTO OFF TIMER SETTING









-  Press menu button to display the menu
-  Press left/right button to select the Time, and press OK
-  Press up/down button to select the Off Time, and press OK
-  Adjustments Repeat-->OFF, Once Everyday, Mon ~ Fri, Mon ~ Sat, Sat ~ Sun or Sun.
Adjustments Hour
Adjustments Minute
-  After finish to select the close and press OK to exit the menu



- Press the EXIT button to close the menu window.
- Press the MENU button to move to the previous menu screen.

TIME SETTING

AUTO OFF TIMER SETTING

-  Press menu button to display the menu
-   Press left/right button to select the Time and press OK
-   Press the down button to select the On Time and press OK
-   Adjustments Activate-->OFF,Once, Everyday, Mon ~ Fri, Mon ~ Sat, Sat ~ Sun or Sun.
Adjustments Hour
Adjustments Minute
Adjustments Volume
Adjustments mode-->DTV/Rodio
-   After finish to select the close and press OK to exit the menu





- Press the EXIT button to close the menu window.
- Press the MENU button to move to the previous menu screen.

TIME SETTING

AUTO SHUT-OFF SETTING

If the set is switched on and there is no input signal, it will switch off automatically after 10 minutes.

- 1  Press menu button to display the menu
- 2  Press left/right button to select the Time and press OK
- 3  Press UP/down button to select Auto-Sleep ON





- Press the EXIT button to close the menu window.
- Press the MENU button to move to the previous menu screen.

TIME SETTING

TIME ZONE SETUP

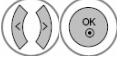
When you select a Time Zone city, the TV time is set by the time offset information based on Time Zone and GMT (Greenwich Mean Time) which is received with the broadcast signal and the time is set automatically by a digital signal.

- 1  Press menu button to display the menu
- 2  Press left/right button to select the and press OK
- 3  Press UP/down button to select Time Zone, Adjustments the Time Zone





- Press the EXIT button to close the menu window.
- Press the MENU button to move to the previous menu screen.

SLEEP TIMER SETTING

You do not have to remember to switch the set off before you go to sleep.

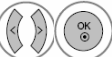
The sleep timer automatically switches the set to standby after the preset time has elapsed.

- 1  Press menu button to display the menu
- 2  Press left/right button to select the and press OK
- 3  Press UP/down button to select SleepTimer, press light button to select the time .OFF/10/20/30/60/90/120/180/240









- Press the EXIT button to close the menu window.
- Press the MENU button to move to the previous menu screen.

PARENTAL CONTROL / RATINGS

SET PASSWORD & LOCK SYSTEM

Enter the password, press '0' '0' '0' '0' on the remote control handset.

- 1  Press menu button to display the menu
- 2   Press left/right button to select the key and press OK
- 3   Press the down button to select the Lock System and press light button to select the On
- 4   Press the down button to select the select and press light button to enter password.

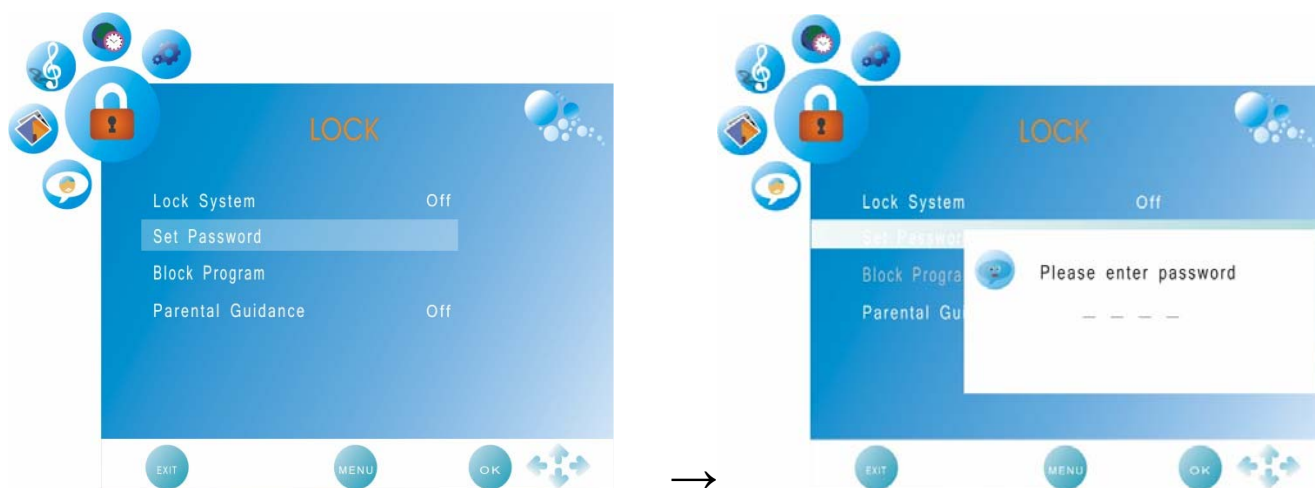







- Press the **EXIT** button to close the menu window.
- Press the **MENU** button to move to the previous menu screen.

PARENTAL CONTROL / RATINGS

BLOCK PROGRAMME

Blocks any programmes that you do not want to watch or that you do not want your children to watch. This function is available in Lock System “On”.

- 1  Press menu button to display the menu
- 2   Press left/right button to select the Lock and press OK,
- 3   Press the down button to select the BLOCK PROGRAMME and Press light button
- 4  Press UP/down button to select the PROGRAMME
- 5  Green Button to locked PROGRAMME

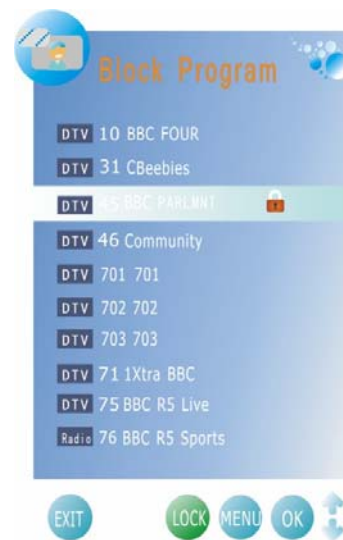
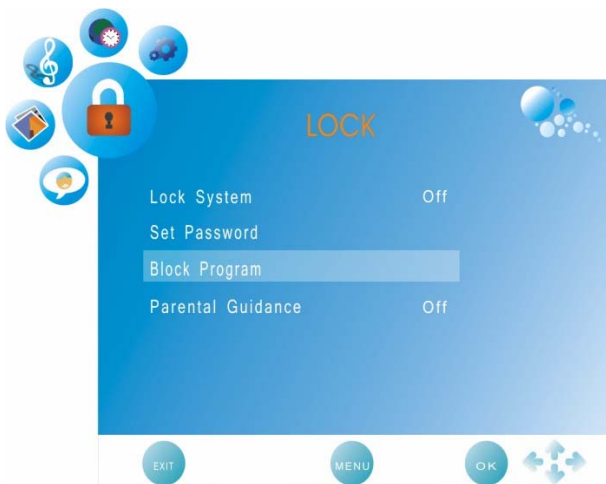

- Press the EXIT button to close the menu window.
- Press the MENU button to move to the previous menu screen.

PARENTAL CONTROL / RATINGS







PARENTAL CONTROL (IN DIGITAL MODE ONLY)

This function operates according to information from the broadcasting station. Therefore if the signal has incorrect information, this function does not operate.

A password is required to gain access to this menu.

This set is programmed to remember which option it was last set to even if you switch the set off.

Prevents children from watching certain adult's TV programmes, according to the ratings limit set.

- 1  Press menu button to display the menu
- 2   Press left/right button to select the Lock and press OK,
- 3   Press the down button to select the Parental Guidance and press OK
- 4  Press left/right button to Adjustments OFF or 4 to 18



- Press the EXIT button to close the menu window.
- Press the MENU button to move to the previous menu screen.

TELETEXT

This feature is not available in all countries.

Teletext is a free service broadcast by most TV stations which gives up-to-the-minute information on news, weather, television programmes, share prices and many other topics.

The teletext decoder of this set can support the SIMPLE, TOP and FASTEXT systems. SIMPLE (standard teletext) consists of a number of pages which are selected by directly entering the corresponding page number. TOP and FASTEXT are more modern methods allowing quick and easy selection of teletext information.

SWITCH ON/OFF

Press the TEXT button to switch to teletext. The initial page or last page appears on the screen.

Two page numbers, TV station name, date and time are displayed on the screen headline. The first page number indicates your selection, while the second shows the current page displayed.

Press the TEXT or EXIT button to switch off teletext. The previous mode reappears.

SIMPLE TEXT

Page selection

1 Enter the desired page number as a three-digit number with the NUMBER buttons. If during selection you press a wrong number, you must complete the three-digit number and then re-enter the correct page number.

2 The PR+ or - button can be used to select the previous or next page.

TOP TEXT

The user guide displays four fields--red, green, yellow and blue at the bottom of the screen. The yellow field denotes the next group and the blue field indicates the next block.

Block / group / page selection

1 With the blue button you can progress from block to block.

2 Use the yellow button to proceed to the next group with automatic overflow to the next block.

3 With the green button you can proceed to the next existing page with automatic overflow to the next group. Alternatively, the PR+ button can be used.

4 The red button permits you to return to previous selection. Alternatively, the PR- button can be used.

Direct page selection

Corresponding to the SIMPLE teletext mode, you can select a page by entering it as a three-digit number using the NUMBER buttons in TOP mode.

APPENDIX







Initializing

(Reset to original factory settings)

This function operates in current mode.

To initialize the adjusted value.

When the Lock System menu is “On”, the message to enter the password appears.



- 1  Press menu button to display the menu
- 2   Press left/right button to select the Setup and press OK ,
- 3   Press the down button to select the Reset and press OK
- 4   Select OK and press OK



- Press the EXIT button to close the menu window.
- Press the MENU button to move to the previous menu screen.

APPENDIX

How to know CI Information

- 1  Press menu button to display the menu
- 2  Press left/right button to select the TV-setting menu and press OK
- 3  Press the down button to select the CI Information and press OK



- Press the EXIT button to close the menu window.
- Press the MENU button to move to the previous menu screen.

APPENDIX

TROUBLESHOOTING

The operation does not work normally.

The remote control doesn't work	<ol style="list-style-type: none">1 Check to see if there is any object between the product and the remote control causing obstruction Ensure you are pointing the remote control directly at the set.2 Ensure that the batteries are installed with correct polarity (+ to +, -to-).3 Ensure that the correct remote operating mode is set: TV, VCR, etc.4 Install new batteries.
Power is suddenly turned off	<ol style="list-style-type: none">1 Is the sleep timer set?2 Check the power control settings. Power interrupted.3 No broadcast on station tuned with Auto sleep activated.

The video function does not work.

No picture &No sound	<ol style="list-style-type: none">1 Check whether the product is turned on.2 Try another channel. The problem may be with the broadcast.3 Is the power cord inserted into wall power outlet?4 Check your antenna direction and/or location.5 Test the wall power outlet, plug another product's power cord into the outlet where the product's power cord was plugged in.
Picture appears slowly after switching on	A This is normal, the image is muted during the product startup process. Please contact your service centre, if the picture has not appeared after five minutes.
No color, poor colour,or poor picture	<ol style="list-style-type: none">1 Adjust Colour in menu option.2 Keep a sufficient distance between the product and the VCR.3 Try another channel. The problem may be with the broadcast.4 Are the video cables installed properly?5 Activate any function to restore the brightness of the picture.
Horizontal/vertical bars or picture shaking	Check for local interference such as an electrical appliance or power tool.
Poor reception on some channels	<ol style="list-style-type: none">1 Station or cable product experiencing problems, tune to another station.2 Station signal is weak, reorient antenna to receive weaker station.3 Check for sources of possible interference.
Lines or streaks in pictures	Check antenna (Change the direction of the antenna).

APPENDIX

The audio function does not work.	
Picture OK & No sound	<ol style="list-style-type: none">1 Press the VOL + or - button.2 Sound muted? Press MUTE button.3 Try another channel. The problem may be with the broadcast.4 Are the audio cables installed properly?
No output from one of the speakers	<ol style="list-style-type: none">1 Adjust Balance in menu option.
Unusual sound from inside the product	<ol style="list-style-type: none">1 A change in ambient humidity or temperature may result in an unusual noise when the product is turned on or off and does not indicate a problem with the product.

Only RGB mode applied

No image is displayed.	
Power is on, power indicator is blue but the screen appears extremely dark.	Adjust brightness and contrast again.
Does the power indicator look amber?	<ol style="list-style-type: none">1 If the product is in power saving mode, move the mouse or press any key.2 A In DVD Player or Set-top Box, check the power status of connected device.
Does the 'Out of range' message appear?	A The signal from the PC (Video card) is out of the vertical or horizontal frequency range of the product. Adjust the frequency range by referring to the Specifications in this user's guide.
Does the 'Check signal cable' message appear?	<ol style="list-style-type: none">1 The signal cable between PC and product is not connected. Check the signal cable.2 Press the 'INPUT' button in the remote control to check the input signal.
Does the 'Check signal cable' message appear?	<ol style="list-style-type: none">1 The signal cable between PC and product is not connected. Check the signal cable.2 Press the 'INPUT' button in the remote control to check the input signal.

APPENDIX

Only RGB mode applied

The screen image looks abnormal.	
Is the screen position wrong?	1 Adjust the Position menu in OSD. 2 See if the video card resolution and frequency are supported by the product. If the frequency is out of range, set to the recommended resolution in the Control Panel-Display-Setting menu.
Do thin lines appear on the background screen?	Adjust the Clock menu in OSD.
Horizontal noise appears or the characters look blurred.	Adjust the Phase menu in OSD.

After-image appears on the product.	
After-image appears when the product is turned off.	If you use a fixed image for a long time, the pixels may be damaged quickly. Use the screen saver function.

Screen color is abnormal.	
Screen has poor color resolution (16_colors).	Set screen color resolution to more than 24 bits (true color)Select control Panel-Display-Settings-Color Table menu in Windows.
Screen color is unstable or mono color.	Check the connection status of the signal cable.
Do back spots appear on the screen?	Several pixels (red, green, white or black color) may appear on the screen, which can be attributable to the unique characteristics of the LCD panel. It is not a malfunction of the LCD.

APPENDIX

MAINTENANCE

Early malfunctions can be prevented. Careful and regular cleaning can extend the amount of time you can enjoy your new set.

Caution: Be sure to turn the power off and unplug the power cord before you begin any cleaning.

Cleaning the Screen

① To keep the dust off your screen for a while, wet a soft cloth in a mixture of lukewarm water and a little fabric softener or dishwashing detergent. Wring the cloth until it's almost dry, and then use it to wipe the screen.

② Make sure the excess water is off the screen, and then let it air-dry before you turn on your set.

Cleaning the Cabinet

To remove dirt or dust, wipe the cabinet with a soft, dry, lint-free cloth.

Please be sure not to use a wet cloth.

Extended Absence

If you expect to leave your set dormant for a long time (such as a vacation), it's a good idea to unplug the power cord to protect against possible damage from lightning or power surges.

▲ CAUTION

If you expect to leave your set dormant for a long time (such as a vacation), it's a good idea to unplug the power cord to protect against possible damage from lightning or power surges.

PRODUCT SPECIFICATIONS

Model : FH-22LMG

LCD Panel	Screen Type	TFT LCD (Liquid Crystal Display) Panel
Video Signal	Max. Resolution	1680 X 1050 @60 Hz
	Recommended Resolution	1680 X 1050 @60 Hz
	Horizontal Frequency	30 - 83 kHz
	Vertical Frequency	56 - 75 Hz
	Synchronization Type	Separate Sync, Digital
Input Connector		TV, D-Sub Analog, HDMI, YPbPr, SCART*1, AV Video, PC Audio In, HEADPHONE OUT
Power	Rated Voltage	AC220-240V [~] 50/60 Hz 1.0A
	Power Consumption	On Mode:55W(Max) 49W(typ.)
		Sleep Mode \leq 1W
		Off Mode \leq 1W
Dimensions (Width x Height x Depth)		610mmx510mmx210mm
Weight		5.7Kg/6.6Kg
Environmental conditions	Operating Temperature	10 ~ 35° C
	Operating Humidity	20 ~ 80%
	Storage Temperature	-10 ~ 60° C
	Storage Humidity	5 ~ 90%